

Article number: 3918049024228

Description: Worm gear with st. steel hollow shaft
VF 49 EP-A-24- 71B14

Measures

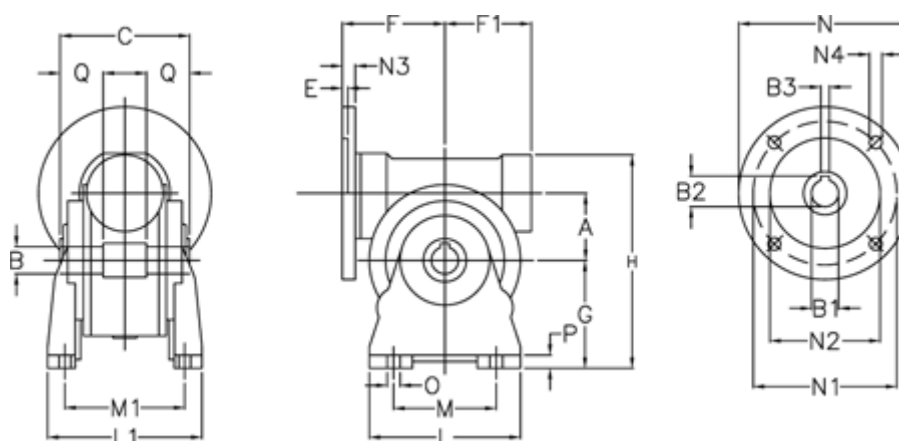

a	= 49.5	F1 = 63	N1 = 85
B	= 25	g = 82	N2 = 70
B1 E7	= 14	H = 162	N3 = 10.5
B2	= 16.3	L = 110	N4 = 6.5
B3 H9	= 5	L1 = 124.0	O = 8.5
C	= 82	m = 63	P = 12
E	= 3.0	M1 = 98.5	Q = 22.5
F	= 70	N = 105	